



Falcon 4M60 / 4M30 Color

Area Scan Cameras



Falcon 4M60/4M30 Color

Key Features

- 4 megapixels
- 60 or 30 fps
- Bayer filter
- Global shutter with exposure control
- Flat field correction (FFC)
- 1000x antiblooming

Programmability

- Adjustable integration time and frame rate
- Individual gain and offset control for each color
- 8 or 10 bit selectable output
- Test pattern and camera diagnostics

Typical Applications

- Electronics manufacturing – AOI, pick and place, and solder paste inspection
- Semiconductor wafer bump inspection
- Intelligent traffic systems
- Flat panel display inspection
- Industrial metrology
- General machine vision

Overview

Global shutter technology, 60 fps, 4 megapixels of resolution, and color.

DALSA provides a colorful solution to the growing need for large resolution, high speed, color image capture in machine vision. The new Falcon 4M60 and 4M30 cameras offer 4 megapixel data rates and 60 or 30 fps, combined with global shuttering for crisp, clear, and colorful imaging.

The 4M cameras use a global shutter to eliminate the imaging issues often associated with full frame, frame transfer, or rolling shutter cameras, such as smearing or time displacement artifacts, and which are particularly damaging when imaging in color.

Similar to the Falcon 4M60 and 4M30 monochrome cameras, the Falcon color cameras incorporate easy-to-use features such as exposure control, individual color gain and offset adjustment, and flat-field correction (FFC) which removes FPN, PRNU, and other non-uniformities associated with imaging.

Specifications

Resolution	2352 x 1728
Data Rate	4 x 80 MHz
Max. Line/Frame Rate	60 fps (4M60) / 30 fps (4M30)
Pixel Size	7.4 μ m
Data Format	8, 10 bit
Output	Base, Medium Camera Link
Lens Mount	M42 x 1, F
Responsivity	14 DN/(nJ/cm ²) @ 1x gain @ 650 nm (Red) 11.5 DN/(nJ/cm ²) @ 1x gain @ 540 nm (Green) 8 DN/(nJ/cm ²) @ 1x gain @ 460 nm (Blue)
Dynamic Range	56 dB
Nominal Gain Range	Up to 4x
Size	94 x 94 x 50 mm
Mass	<550 g
Operating Temp	0 °C to 50 °C
Power Supply	12V to 15V DC
Power Dissipation	<10 W
Regulatory Compliance	CCE, RoHS
Control	MDR26 Camera Link
Data	Shared with Control
Power	Hirose 6 pin
Example Part Number	PT-42-04M60-03-R

Falcon 4M60 / 4M30 Color

Area Scan Cameras

At 60 or 30 fps, the 4 megapixel 4M color cameras deliver 4 times more speed than comparable ILT cameras. Using Camera Link and the same optical format as our 4M15, retrofitting the new 4M color cameras into existing 4 megapixel systems is simple.

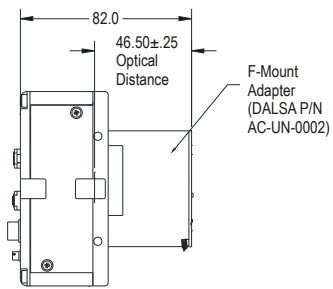
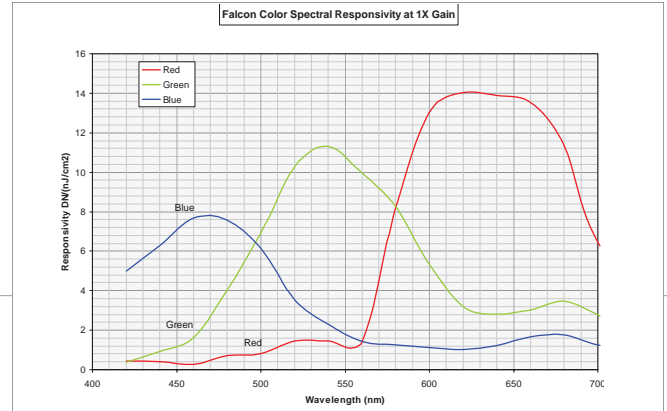

F-MOUNT CONFIGURATION

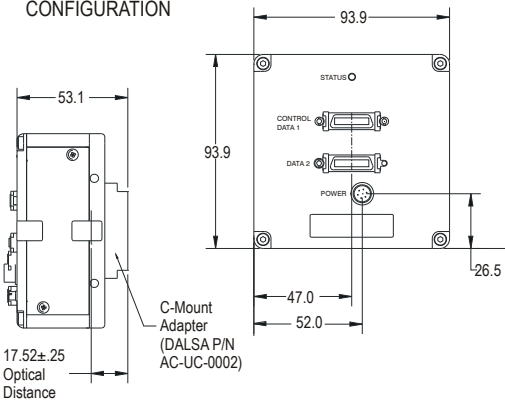

C-MOUNT CONFIGURATION

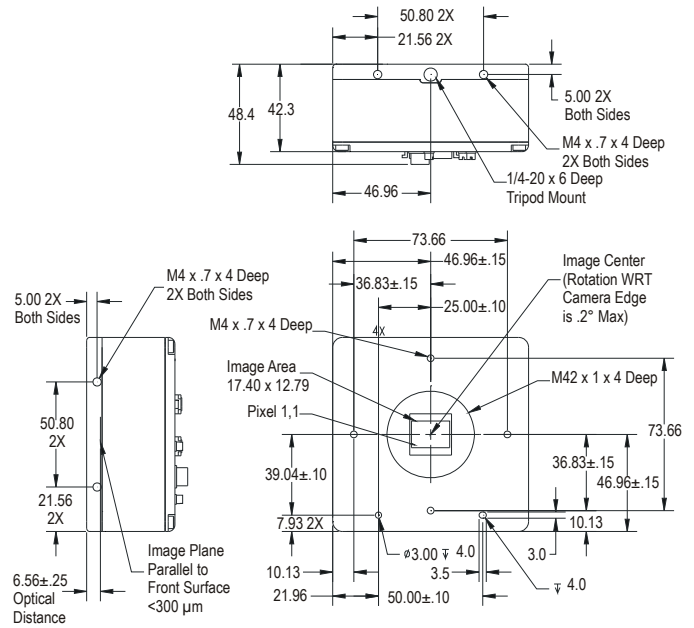

Tolerance Unless Otherwise Specified:
X±.5
XX±.30

www.dalsa.com

Americas
Boston, USA
Tel: +1 978-670-2000
sales.americas@dalsa.com

Europe
Munich, Germany
Tel: +49 8142-46770
sales.europe@dalsa.com

Asia Pacific
Tokyo, Japan
+81 3-5960-6353
sales.asia@dalsa.com

DALSA is an international leader in digital imaging and semiconductors and has its corporate offices in Waterloo, Ontario, Canada.

All trademarks are registered by their respective companies. DALSA reserves the right to make changes at any time without notice. © DALSA 2008. 03-070-20023-00

