



**adept**  
**electronic solutions**

**The Machine Vision and  
Imaging Specialists**

Perth: +61 (08) 9242 5411  
Sydney: +61 (02) 9979 2599  
Melbourne: +61 (03) 9555 5621  
Email: [adept@adept.net.au](mailto:adept@adept.net.au)  
Web: <http://www.adept.net.au>



# C4<sup>®</sup> -2040-GigE

## *High Speed 3D Measurement*

- High resolution and high speed CMOS camera
- Enhanced 3D imaging with High Dynamic Range 3D profiling technology (HDR-3D)
- Integrated 3D-profile high precision algorithms up to 32000 Profiles/s
- GigE Vision interface, GenICam compliant
- Flexible trigger interfaces
- Integrated illumination control

 **Automation Technology**  
Vision Systems for Automation

[www.adept.net.au](http://www.adept.net.au)

## C4<sup>®</sup>-2040-GigE unmatched performance and flexibility for 3D imaging

The C4<sup>®</sup>-2040-GigE is a revolution for three dimensional shape measurement. It offers unique key benefits for OEMs and Vision Integrators while making 3D imaging as easy as 2D vision.

### Measurement Principle

The C4<sup>®</sup> sensor acquires height profiles and height images by means of laser sheet-of-light (triangulation) technique: a laser line is projected on the object, the resulting sensor image is evaluated by the C4<sup>®</sup> camera core and converted into a single height profile. By scanning the laser line over the object a complete height image of the object can be acquired.

### Fastest 3D-Sensor on market

By using the C4<sup>®</sup>-Technology of high speed parallel hardware processors the complete 3D data calculation is done inside the camera. This enables the C4<sup>®</sup>-2040-GigE to acquire up to 32000 profiles per second. For a maximum of flexibility, three profile algorithms are included in the C4<sup>®</sup>-core: TRSH, MAX and COG. Furthermore, the choice of the profile algorithm does not influence the profile speed. This means that the profile data are always output at the same maximum speed.

### Multiple Sensor-AOIs and Multiple-Featureoutput

The C4<sup>®</sup> sensor is capable of delivering position data as well as additional features (e.g. intensity, line width) without sacrificing profile speed. Furthermore up to four sensor AOIs can be defined for dividing the sensor in separate subwindows.

### High quality profile data

All C4<sup>®</sup>-2040 sensors are equipped with a global snapshot shutter for capturing sharp, undistorted images and profile data even for fast moving objects.

### Flexible Trigger Interface

The C4<sup>®</sup> camera contains a configurable trigger interface based on opto-coupled I/O lines and a RS422 shaft encoder with tick counter and direction evaluation. Using this advanced trigger options assures precise profile triggering even at changes of movement velocity.

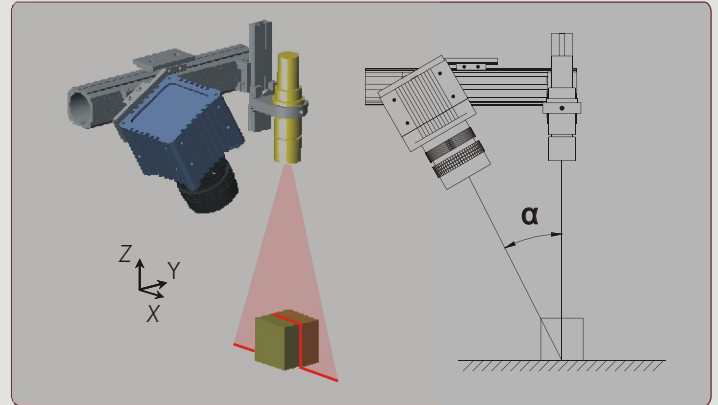

### Easy Integration in Machine Vision Systems

The C4<sup>®</sup> concept is based on Gigabit-Ethernet interface and complies to GigE standard. Through the GenICam protocol the integration effort is minimised. We support our customer with an API and a standalone tool for configuring the camera. Once the camera is configured it boots up using the predefined configuration without any camera specific programming. Furthermore, the camera FPGA allows the storage of up to 4 different firmware versions, which can be field updated at any time.

### Available Options



## 3D - Imaging solution for numerous applications

The C4<sup>®</sup>-2040-GigE provides a powerful solution to a broad field of industrial 3D- applications

### Inspection of tyres and rubber gaskets

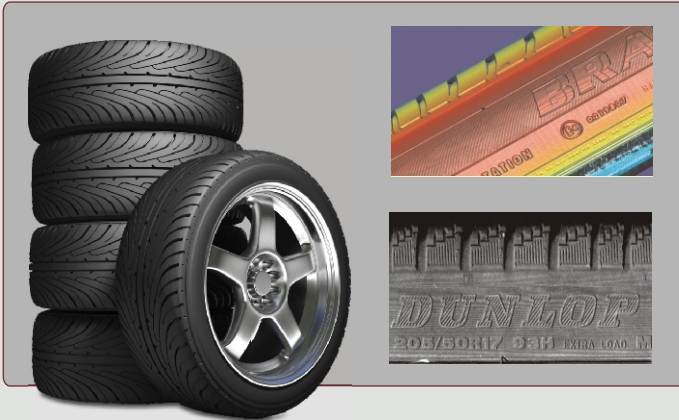

### Inspection of connection rods

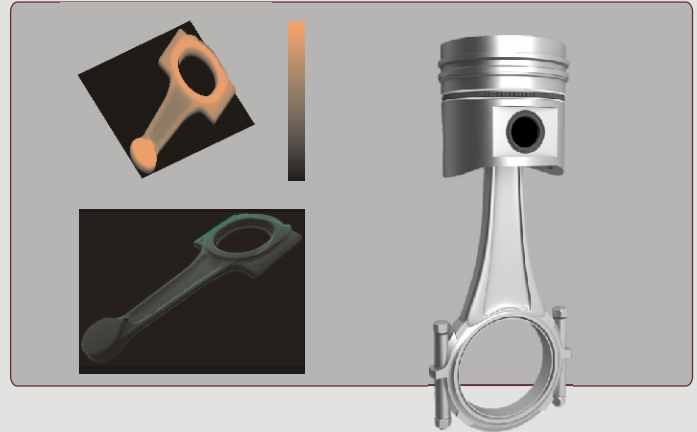

### Inspection of Printed Circuit Boards (PCB)

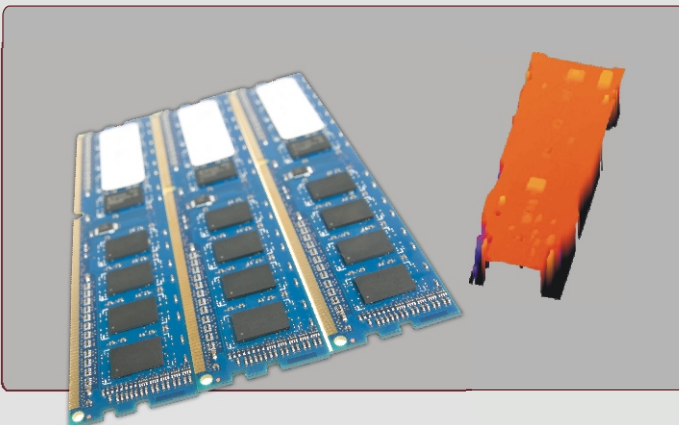

### Inspection of glue beads

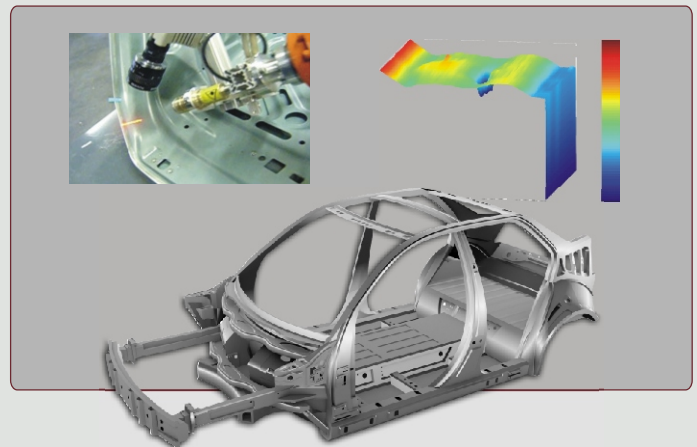

### 3D Inspection of Packaging

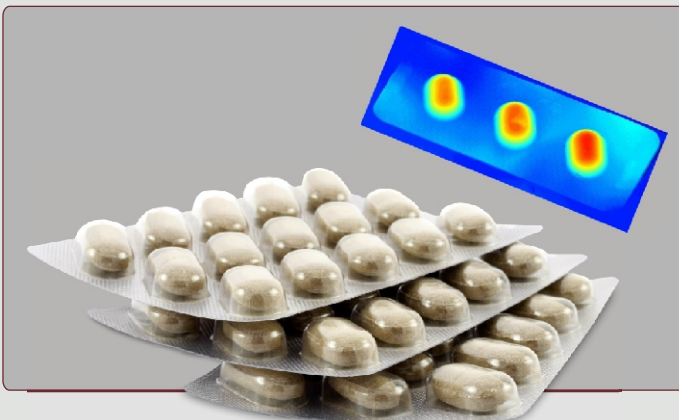

### Inspection of Sintered Components

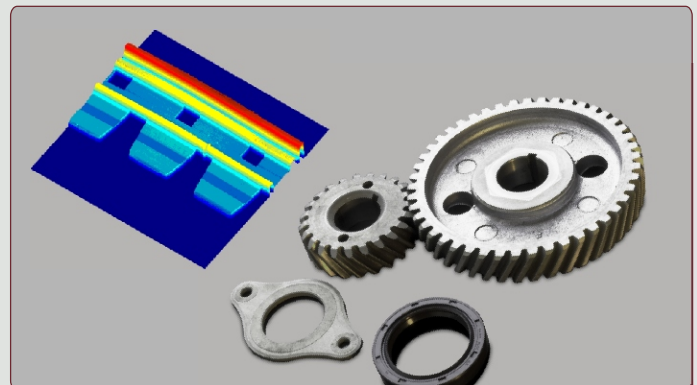

# C4<sup>®</sup> -2040-GigE

Sensor Specifications			
Pixels	2048 x 1088 (or C4-2040-4M-GigE with 2048 x2048 pixels)		
Pixel size	5.5µm x 5.5µm		
Dynamic range	90dB with High Dynamic Range 3D (HDR-3D)		
Digitization	10Bit		
Shutter	Global Shutter with Multiple Slopes and Non-Destructive Readout		
Sensitivity	4000 LSB/(µJ cm <sup>2</sup> ) @ 550nm		
Sensor algorithm	Image, Profile-MAX, Profile-TRSH, Profile-COG		
Length of profile in 3D-mode	2048 pixels per profile		
Typical profile speed depending on number of sensor rows	Sensor rows	Profile speed (Hz) with 2048 pixels	
	Height resolution can be increased by using Profile-TRSH (1/2 pixel) or Profile-COG (1/64 pixel) without loss of speed	2048* 1088 256 128 64 16 8	
	*Only C4-2040-4M-GigE		
Max. frame rate for image mode (full frame)	340 fps (internal memory) C4-2040-4M-GigE: 180 fps (internal memory)		
Interface Specifications			
Digital I/O's and external synchronisation signals (MDR20 connector)	2 opto-coupled inputs, 2 opto-coupled outputs, Laser control interface Inputs can be configured as image and profile trigger, RS422 Resolver interface with signals A,/A,B,/B, tick divider and direction evaluation		
Illumination interface (5-pin M9 connector)	To control line laser projectors		
Video output	GigE Vision with GenICam protocol		
Power Requirements			
Power supply	10 - 24V		
Power consumption	< 10W		
Mechanical Specifications			
Lens mount	M42 x 1 with Back Focal Distance 6,52 mm (requires adapter for C-/F-Mount lens)		
Size	68mm x 68mm x 59mm (C-Mount) / 88mm (F-Mount)		
Mass (without optics)	340g (C-Mount) / 410g (F-Mount)		
Housing mount	4 x M3 on each side		
Environmental Specifications			
Operating temperature	0°C to +50°C (non condensing)		
Storage temperature	-30°C to +70°C (non condensing)		
General			
PC requirements	Gigabit Ethernet		
Operating systems	Windows 7, XP, Vista, WIN NT, 2000, Linux (on request)		
Software environment	Configuration tool CX-Explorer, GenICam API, Compatible with any GigE vision compliant image processing library, e.g. CVB, NI-IMAQ, HALCON, MIL, VisionPro		



Automation Technology GmbH  
Hermann-Bössow-Straße 6-8  
D-23843 Bad Oldesloe

Telefon: +49-(0) 45 31 / 88011-0  
Telefax: +49-(0) 45 31 / 88011-20  
E-Mail: info@automationtechnology.de  
Internet: www.automationtechnology.de

[www.adept.net.au](http://www.adept.net.au)

**Sales contact:**